

# ÉLÉMENTS MÉCANIQUES NORMALISÉS



## CLAVETTE DIN



*Bridage DIN*  
*Bridage rapide Sauterelles*  
*Flexibles d'arrosage*  
*Lampes pour machine-outil*  
**Outillage**

## **Clavettes DIN**

**Goupilles DIN**  
**Plots anti-vibratoires**  
**Canons de perçage DIN**  
**Clavettes DIN**  
*Goupilles élastiques*

# DIN 6885 A - CLAVETTES PARALLÈLES

(Pour clavetage libre)



**Acier F-114**



**Traité**



Sur demande nous pouvons vous fournir ces pièces en acier inoxydable - AISI - 316  
Prix et délai, nous consulter.

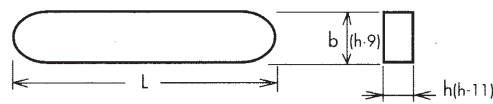

Forme A

Tolérances de fabrication

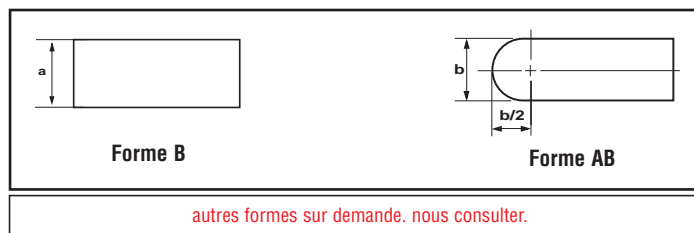

autres formes sur demande. nous consulter.

Référence	b x h (mm)	Longueurs normalisées disponibles (mm)
6885A/2x2 x longueur	2x2	8, 16, 20
6885A/3x3 x longueur	3x3	8, 10, 12, 14, 15, 16, 18, 20, 22, 25, 30, 36, 40
6885A/4x4 x longueur	4x4	8, 10, 12, 14, 15, 16, 18, 20, 22, 25, 28, 30, 32, 35, 40
6885A/5x5 x longueur	5x5	10, 12, 14, 15, 16, 18, 20, 22, 25, 28, 30, 32, 35, 36, 40, 45, 50, 55, 56, 60
6885A/6x6 x longueur	6x6	8, 10, 12, 14, 15, 16, 18, 20, 22, 25, 28, 30, 32, 35, 36, 40, 45, 50, 55, 56, 60, 63, 65, 70, 80, 90
6885A/8x7 x longueur	8x7	14, 15, 16, 18, 20, 22, 25, 28, 30, 32, 35, 36, 40, 45, 50, 55, 56, 60, 63, 65, 70, 80, 90, 100, 110
6885A/10x8 x longueur	10x8	20, 22, 25, 28, 30, 32, 35, 36, 40, 45, 50, 55, 56, 60, 63, 65, 70, 80, 90, 100, 110, 120, 125
6885A/12x8 x longueur	12x8	20, 22, 25, 28, 30, 32, 35, 36, 40, 45, 50, 55, 56, 60, 63, 65, 70, 80, 90, 100, 110, 120, 125, 130, 140
6885A/14x9 x longueur	14x9	25, 28, 30, 32, 35, 36, 40, 45, 50, 55, 56, 60, 63, 65, 70, 80, 90, 100, 110, 120, 125, 130, 140
6885A/16x10 x longueur	16x10	30, 32, 35, 36, 40, 45, 50, 55, 56, 60, 63, 65, 70, 80, 90, 100, 110, 120, 125, 130, 140, 150
6885A/18x11 x longueur	18x11	40, 45, 50, 55, 56, 60, 63, 65, 70, 80, 90, 100, 110, 120, 125, 130, 140, 150
6885A/20x12 x longueur	20x12	70, 80, 90, 100, 110, 120, 125, 130, 140, 150, 160, 180, 200
6885A/22x14 x longueur	22x14	70, 80, 90, 100, 110, 120, 125, 130, 140, 150, 160, 180, 200
6885A/25x14 x longueur	25x14	70, 80, 90, 100, 110, 120, 125, 130, 140, 150, 160, 180, 200
6885A/28x16 x longueur	28x16	70, 80, 90, 100, 110, 120, 125, 130, 140, 150, 160, 180, 200, 220
6885A/32x18 x longueur	32x18	80, 90, 100, 110, 120, 125, 140, 150, 160, 180, 200, 220
6885A/36x20 x longueur	36x20	100, 110, 120, 125, 140, 150, 160, 180, 200, 220
6885A/40x22 x longueur	40x22	100, 110, 120, 125, 140, 150, 160, 180, 200, 220, 250
6885A/45x25 x longueur	45x25	125, 140, 150, 160, 180, 200, 220, 250

# DIN 6880 - BARREAU ETIRE

Pour réalisation de clavettes parallèles



**XC45**



**Etiré**



Section carrée

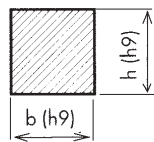

Section rectangulaire

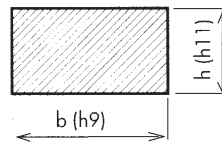

**2 longueurs disponibles sur stock : 500 mm et 1 m**

Référence	Dim. b x h (mm)	Longueur (mm)
6880/3x3x500	3x3	500
6880/4x4x500	4x4	500
6880/5x3x500	5x3	500
6880/5x5x500	5x5	500
6880/6x4x500	6x4	500
6880/6x6x500	6x6	500
6880/7x7x500	7x7	500
6880/8x5x500	8x5	500
6880/8x6x500	8x6	500
6880/8x7x500	8x7	500
6880/8x8x500	8x8	500
6880/10x6x500	10x6	500
6880/10x8x500	10x8	500
6880/10x10x500	10x10	500
6880/12x8x500	12x8	500
6880/12x10x500	12x10	500
6880/12x12x500	12x12	500
6880/14x9x500	14x9	500
6880/14x14x500	14x14	500
6880/16x10x500	16x10	500
6880/16x16x500	16x16	500
6880/18x11x500	18x11	500
6880/18x18x500	18x18	500
6880/20x12x500	20x12	500
6880/20x20x500	20x20	500
6880/22x14x500	22x14	500
6880/24x14x500	24x14	500
6880/25x14x500	25x14	500
6880/28x16x500	28x16	500
6880/32x18x500	32x18	500
6880/36x20x500	36x20	500
6880/40x22x500	40x22	500
6880/45x25x500	45x25	500
6880/50x28x500	50x28	500

Référence	Dim. b x h (mm)	Longueur (mm)
6880/3x3x1000	3x3	1000
6880/4x4x1000	4x4	1000
6880/5x3x1000	5x3	1000
6880/5x5x1000	5x5	1000
6880/6x4x1000	6x4	1000
6880/6x6x1000	6x6	1000
6880/7x7x1000	7x7	1000
6880/8x5x1000	8x5	1000
6880/8x6x1000	8x6	1000
6880/8x7x1000	8x7	1000
6880/8x8x1000	8x8	1000
6880/10x6x1000	10x6	1000
6880/10x8x1000	10x8	1000
6880/10x10x1000	10x10	1000
6880/12x8x1000	12x8	1000
6880/12x10x1000	12x10	1000
6880/12x12x1000	12x12	1000
6880/14x9x1000	14x9	1000
6880/14x14x1000	14x14	1000
6880/16x10x1000	16x10	1000
6880/16x16x1000	16x16	1000
6880/18x11x1000	18x11	1000
6880/18x18x1000	18x18	1000
6880/20x12x1000	20x12	1000
6880/20x20x1000	20x20	1000
6880/22x14x1000	22x14	1000
6880/24x14x1000	24x14	1000
6880/25x14x1000	25x14	1000
6880/28x16x1000	28x16	1000
6880/32x18x1000	32x18	1000
6880/36x20x1000	36x20	1000
6880/40x22x1000	40x22	1000
6880/45x25x1000	45x25	1000
6880/50x28x1000	50x28	1000

# DIN 6880SS - BARREAU ETIRE INOX

*Pour réalisation de clavettes parallèles*



**Acier inoxydable  
AISI 316 (A4)**



**Etiré**



Section carrée

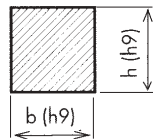

Section rectangulaire

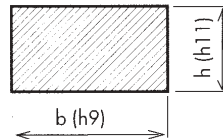

Permet de réaliser des clavettes pour les industries alimentaires, chimiques, etc.

**1 longueur disponible sur stock : 1 m**

Référence	Dim. b x h (mm)	Longueur (mm)
6880SS/3x3x1000	3x3	1000
6880SS/4x4x1000	4x4	1000
6880SS/5x5x1000	5x5	1000
6880SS/6x6x1000	6x6	1000
6880SS/8x7x1000	8x7	1000
6880SS/10x8x1000	10x8	1000
6880SS/12x8x1000	12x8	1000
6880SS/14x6x1000	14x6	1000
6880SS/14x9x1000	14x9	1000
6880SS/16x10x1000	16x10	1000
6880SS/18x11x1000	18x11	1000
6880SS/20x12x1000	20x12	1000

# DIN 6888 - CLAVETTES DISQUES



**XC45**



**Traité**

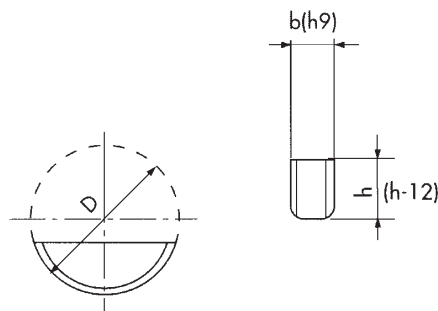

Tolérances de fabrication.

Référence	b (mm)	h (mm)	D (mm)
6888/2x3,7x10	2	3,7	10
6888/2,5x3,7x10	2,5	3,7	10
6888/3x3,7x10	3	3,7	10
6888/3x5x13	3	5	13
6888/3x6,5x16	3	6,5	16
6888/4x5x13	4	5	13
6888/4x6,5x16	4	6,5	16
6888/4x7,5x19	4	7,5	19
6888/5x6,5x16	5	6,5	16
6888/5x7,5x19	5	7,5	19
6888/5x9x22	5	9	22
6888/6x7,5x19	6	7,5	19
6888/6x9x22	6	9	22
6888/6x10x25	6	10	25
6888/6x11x28	6	11	28
6888/8x9x22	8	9	22
6888/8x11x28	8	11	28
6888/8x13x32	8	13	32
6888/10x11x28	10	11	28
6888/10x13x32	10	13	32
6888/10x16x45	10	16	45